

Features

- One-piece toilets integrate the tank and bowl into a seamless, easy-to-clean design.
- Round-front bowl offers an ideal solution for smaller bathrooms and powder rooms.
- Low-profile design.
- 1.28 gpf (4.8 lpf).
- Left-hand Polished Chrome trip lever.
- Includes K-4009 Reveal® Quiet-Close™ seat.

Technology

- Single-flush gravity uses the force of gravity and a precision-engineered tank, bowl, and trapway to create a strong siphon during flushing.
- AquaPiston® canister allows water to flow into the bowl from all sides (360°), increasing the power and effectiveness of the flush.
- Flush valve's 3:2 ratio harnesses the natural force of gravity and optimizes flush performance.
- Durable canister design has 90% less exposed seal material than a 3" flapper for leak-free performance.
- Light-touch canister flush requires a lower actuation force than a flapper.

Installation

- Standard 12" (305 mm) rough-in.
- Supply line sold separately.

Water Conservation & Rebates

- Eligible for consumer rebates in some municipalities.

Recommended Products/Accessories

- K-75758 Cachet® Nightlight Quiet-Close™ round-front toilet seat
- K-5420 Low-Profile Bolt Caps
- K-9176 Trip Lever
- 1023457
- 1265114
- K-23726 Drain treatment

Included Components

- Additional Components:
- Bolt cap accessory pack
 - Tank Accessory Pack
 - Tank Cover
 - Trip Lever



Codes/Standards







ASME A112.19.2/CSA B45.1
DOE - Energy Policy Act 1992
EPA WaterSense®

KOHLER® Toilets and Seats Limited Warranty

See website for detailed warranty information.

Available Colors/Finishes

Color tiles intended for reference only.

Color	Code	Description
	0	White
	96	Biscuit
	NY	Dune
	95	Ice™ Grey
	58	Thunder™ Grey
	7	Black Black™

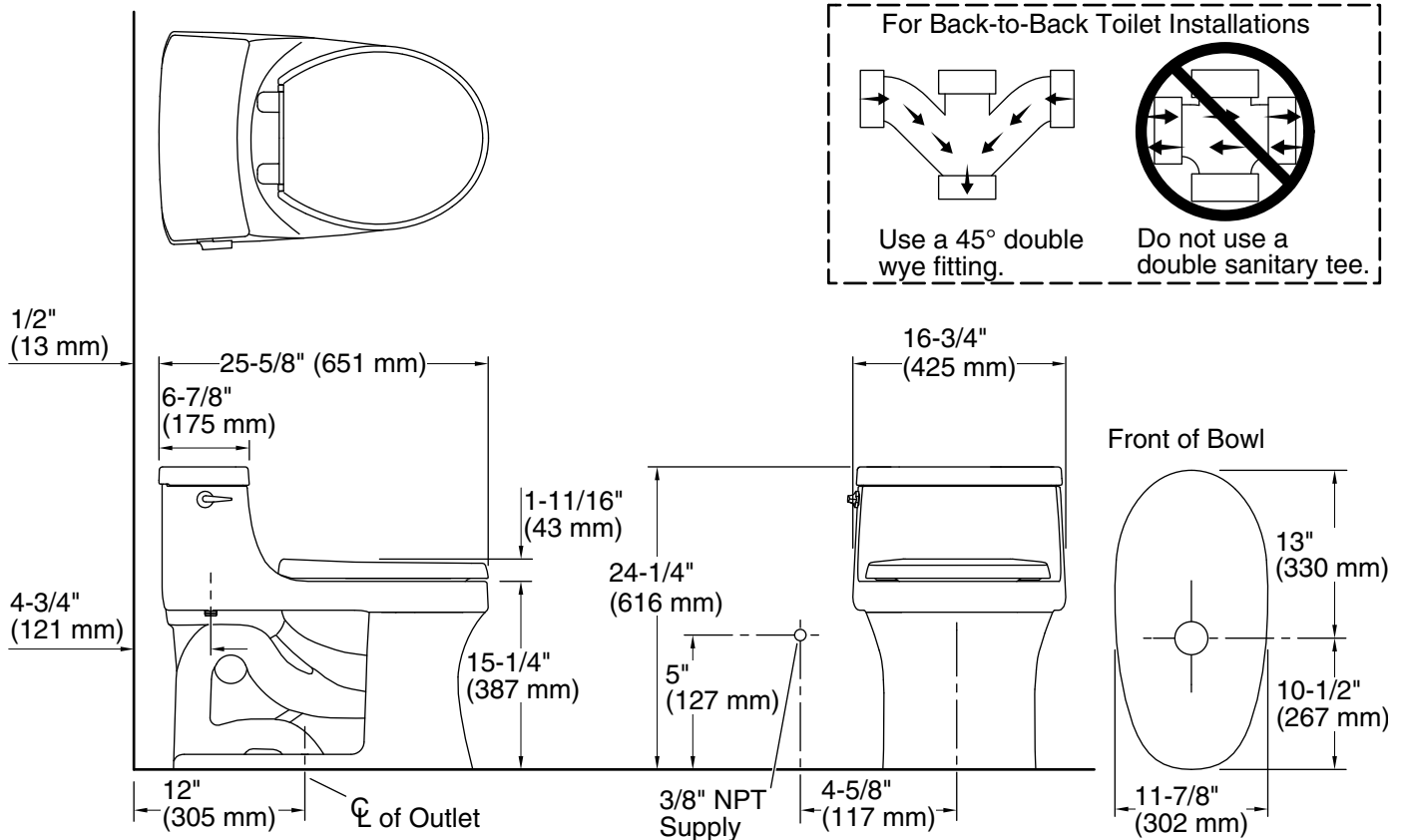

Technical Information

All product dimensions are nominal.

Toilet type:	Floor-mount
Waste Outlet:	Floor
Bowl shape:	Round-front
Flush type:	AquaPiston®
Trap passageway:	2-1/8" (54 mm)
Water Consumption	
Full:	1.28 gpf (4.8 lpf)
Water surface size:	9-1/4" x 6-3/4" (235 mm x 171 mm)
Rim to water surface:	6-5/16" (160 mm)
Rough-in:	12" (305 mm)
Seat-mounting holes:	5-1/2" (140 mm)

Fixture Supply Requirements

Min static pressure:	20 psi (137.9 kPa)
Max static pressure:	80 psi (551.6 kPa)

Notes

Install this product according to the installation instructions.

For back-to-back toilet installations: Use only a 45° double wye fitting.